

WISeNET

BabyView ³eco PT
Wireless PT Video Baby Monitor

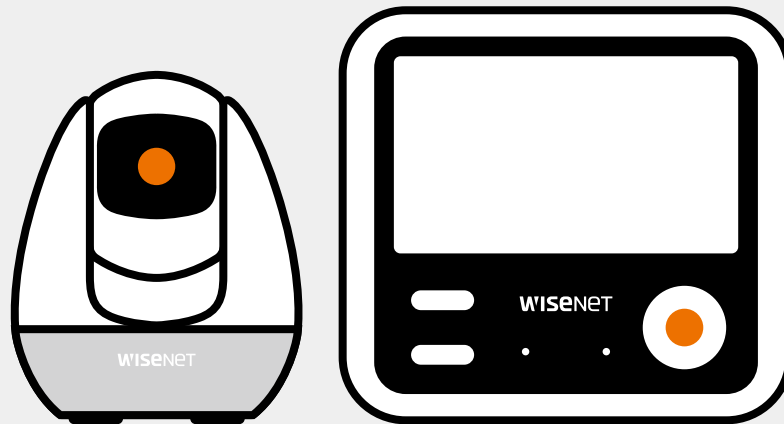

User Manual

SEW-3049W

CAUTION

- Risk of explosion if battery is replaced by an incorrect type.
- Immediately discontinue use of the product if the battery or battery door is swollen or bulging which may be a precursor to overheating batteries.
- It is good practice to periodically remove the battery door at the back of the monitor to check if the battery has any signs of deformations.
- Do not let a loose battery come in contact with metal objects such as coins, keys or jewellery.
- Dispose of used batteries according to the instructions.
- If the battery is not fully charged after 7 hours, stop charging immediately. Overcharging may cause fire, burns or injuries.
- Please use the product in a room-temperature environment. The usage of the monitor in extremely high temperature or low temperature will shorten the lifespan of the battery. (ex. Leaving the product in a closed automobile during summer will affect the battery lifespan).
- This battery is expendable. If you noticed the battery has stopped charging or that the battery's usage time has shortened drastically, stop using the product immediately.

BabyView eco PT

User Manual

Copyright

©2018 Hanwha Techwin Co., Ltd. All rights reserved.

Trademark

Each of trademarks herein is registered. The name of this product and other trademarks mentioned in this manual are the registered trademark of their respective company.

Restriction

Copyright of this document is reserved. Under no circumstances, this document shall be reproduced, distributed or changed, partially or wholly, without formal authorization.

Disclaimer

Hanwha Techwin makes the best to verify the integrity and correctness of the contents in this document, but no formal guarantee shall be provided. Use of this document and the subsequent results shall be entirely on the user's own responsibility. Hanwha Techwin reserves the right to change the contents of this document without prior notice.

IMPORTANT SAFETY INSTRUCTIONS

1. Read these instructions.
2. Keep these instructions.
3. Heed all warnings.
4. Follow all instructions.
5. Do not use this apparatus near water.
6. Clean only with dry cloth.
7. Do not block any ventilation openings, install in accordance with the manufacturer's instructions.
8. Do not install near any heat sources such as radiators, heat registers, stoves, or other apparatus (including amplifiers) that produce heat.
9. Do not defeat the safety purpose of the polarized or grounding-type plug. A polarized plug has two blades with one wider than the other. A grounding type plug has two blades and a third grounding prong. The wide blade or the third prong are provided for your safety. If the provided plug does not fit into your outlet, consult an electrician for replacement of the obsolete outlet.
10. Protect the power cord from being walked on or pinched particularly at plugs, convenience receptacles, and the point where they exit from the apparatus.
11. Only use attachments/ accessories specified by the manufacturer.
12. Unplug this apparatus during lightning storms or when unused for long periods of time.
13. Refer all servicing to qualified service personnel. Servicing is required when the apparatus has been damaged in any way, such as power-supply cord or plug is damaged, liquid has been spilled or objects have fallen into the apparatus, the apparatus has been exposed to rain or moisture, does not operate normally, or has been dropped.

SPECIFY SERVICE INSTRUCTIONS AND WARRANTY TERMS

FCC Compliance Statement

This device complies with part 15 of the FCC rules. Operation is subject to the following two conditions: (1) This device may not cause harmful interference, and (2) this device must accept any interference received, including interference that may cause undesired operation.

FCC Interference Statement

 This equipment has been tested and found to comply with the limits for a Class B digital device, pursuant to part 15 of the FCC Rules. These limits are designed to provide reasonable protection against harmful interference in a residential installation. This equipment generates, uses and can radiate radio frequency energy and, if not installed and used in accordance with the instructions, may cause harmful interference to radio communications. However, there is no guarantee that interference will not occur in a particular installation. If this equipment does cause harmful interference to radio or television reception, which can be determined by turning the equipment off and on, the user is encouraged to correct the interference by one of the following measures:

- Reorient or relocate the receiving antenna.
- Increase the separation between the equipment and receiver.
- Connect the equipment into an outlet on a circuit different from which the receiver is connected.
- Consult the dealer or an experienced radio/TV technician for help.

FCC Caution

Any changes or modifications not expressly approved by the party responsible for compliance could void the user's authority to operate this equipment. This transmitter must not be co-located or operating in conjunction with any other antenna or transmitter.

Industry Canada Statement

This device complies with RSS-247 of the Industry Canada Rules. Operation is subject to the following two conditions: (1) This device may not cause harmful interference, and (2) this device must accept any interference received, including interference that may cause undesired operation.

Ce dispositif est conforme à la norme RSS-247 d'Industrie Canada applicable aux appareils radio exempts de licence. Son fonctionnement est sujet aux deux conditions suivantes: (1) le dispositif ne doit pas produire de brouillage préjudiciable, et (2) ce dispositif doit accepter tout brouillage reçu, y compris un brouillage susceptible de provoquer un fonctionnement indésirable.

Industry Canada Radiation Exposure Statement (Déclaration d'exposition aux radiations)

This equipment complies with IC radiation exposure limits set forth for an uncontrolled environment. This equipment should be installed and operated with minimum distance 20 cm between the radiator & your body.

Cet équipement est conforme aux limites d'exposition aux rayonnements IC établies pour un environnement non contrôlé. Cet équipement doit être installé et utilisé avec un minimum de 20 cm de distance entre la source de rayonnement et votre corps.

WARNING

- STRANGULATION HAZARD - Keep cord out of child's reach. NEVER place camera or cords within 3 feet of crib or playpen. Never use extension cords with AC Adapters. Only use the AC Adapters provided.
- Some adult assembly or installation required.
- This product contains small parts that may cause choking. Keep small parts away from children.
- This product is NOT intended to replace proper supervision of children. You MUST check your child's activity regularly, as this product will not alert parents to silent activities of a child.

- Before using this product, read and follow all instructions contained in this booklet, and read and follow all instructions and warnings on the product.
- NEVER use the transmitter or monitor near water, including near a bathtub, sink, laundry tub, wet basement, etc.
- This product is intended for indoor use only.
- This product is not intended for use as a medical monitor and its use should not replace adult supervision.
- The transmitter detects normal sound levels within a range of 2 to 3 meters (6 to 10 feet) from a child. If the child moves outside of this range, it may not be able to detect sounds from him or her.
- It is essential that you check the operating range and condition of the transmitter monitor on initial installation, and on a regular basis after that.
- Check reception regularly. Test monitor before use and after changing camera location.
- Do not take apart the product by yourself.
- To prevent overheating, keep the product and AC power adapters away from any direct sunlight and heat sources such as radiators, heat registers, cooking devices (e.g., stoves and ovens) and other appliances that produce heat (e.g., amplifiers, televisions and stereos).
- Ensure that the product is well ventilated during use. Avoid contact with pillows and furniture that may block ventilation.
- Use only the AC adapters provided with the product, as other adapters may damage the product. Plug the adapters only into standard household current (100-240 volts AC). Place the AC adapters avoiding pinch points otherwise you can damage the adapters.
- When an AC adapter is plugged into a power source, DO NOT touch the exposed end of the AC adapter's cord.
- Do not use extension cords with the AC power adapters to avoid entanglement.
- This product should only be serviced by qualified and authorized Hanwha Techwin service centers.
- Images and sounds are transmitted by the product over public airwaves and transmissions may be picked up by other units. (Although the transmission distance is 328ft or longer, it may vary depending on whether there are obstacles between the camera and the monitor.)
- Caution: If you use the system to watch a young child, do not place the camera where the child can reach.
- When using the system with only battery power and the charge is low, then the picture and or sound may be affected.
- If this occurs then please connect the AC power adapter.

The transmission range of the wireless signal may weaken if heavy obstructions such as a concrete, brick, or metal walls are between the camera and monitor, or if there are several Wi-Fi routers and devices in your environment.

To avoid interference with 2.4Ghz RF signal, keep your wireless networks (Wi-Fi routers, Bluetooth systems, or microwave ovens) at least 3ft (1.5m) away from the Camera and Monitor.



What's Included (Package Contents)

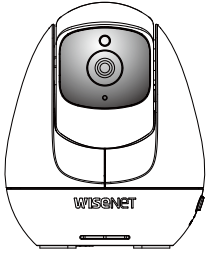

Wireless Camera

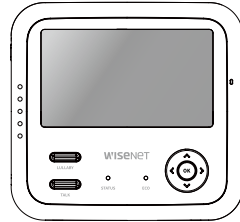

Wireless Monitor

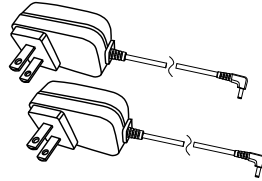

Camera / Monitor Adapters



Mounting Screw Kit

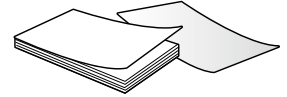

User Manual / Warranty Card



- Check the package to confirm that you have received all the components for the system as shown above.
- You must have more than one camera configured to the system when using functions that require more than one camera.



Product Overview

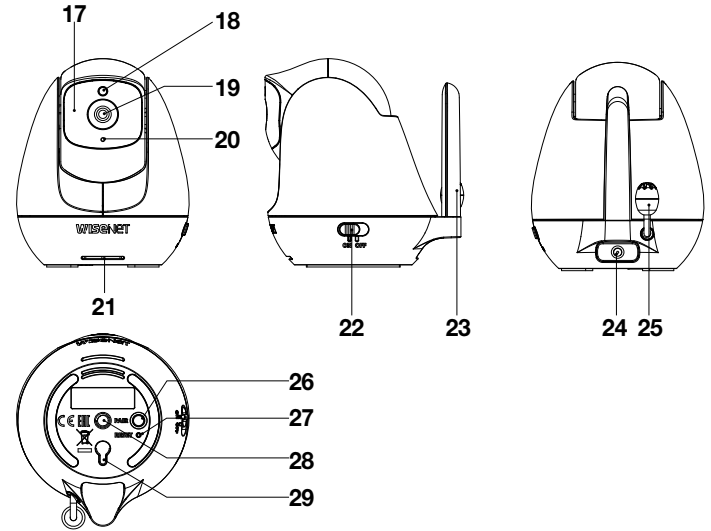
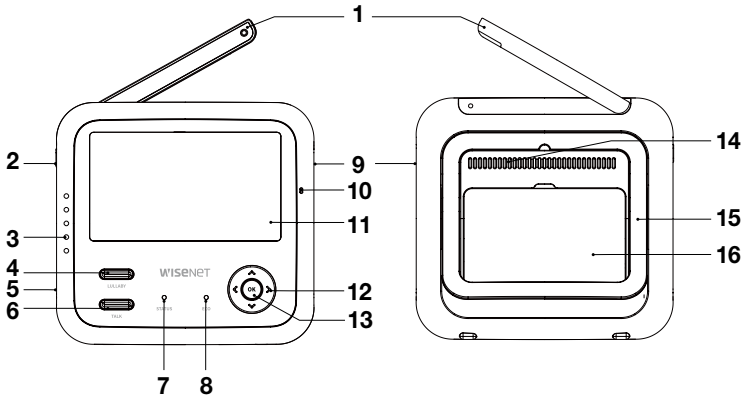

- | | | |
|------------------------|--------------------------|------------------------|
| 1. Antenna | 6. Talk Button | 11. Color TFT 4.3" LCD |
| 2. Power On/Off | 7. Status LED | 12. Direction Button |
| 3. Sound Indicator LED | 8. ECO LED | 13. Menu / OK Button |
| 4. Lullaby Button | 9. Mode Button | 14. Speaker |
| 5. DC 5V Power Input | 10. Microphone (Monitor) | 15. Kick Stand |

- | | | |
|-------------------------|------------------------|---------------------|
| 16. Battery | 21. Speaker | 26. Pair Button |
| 17. IR LEDs | 22. Power Slide Switch | 27. Reset Button |
| 18. Low Light Sensor | 23. Antenna | 28. Tripod Hole |
| 19. Lens | 24. DC 5V Power Input | 29. Wall Mount Hole |
| 20. Microphone (Camera) | 25. Temperature Sensor | |

Getting Started

Powering Your System

Fully charge the monitor's battery before initial use and recharge the monitor as needed.

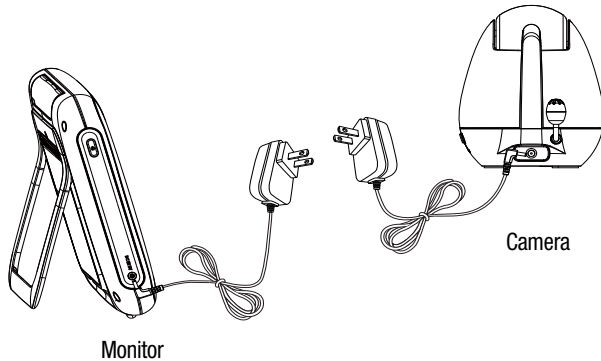

1. Fully charge the system before use. Connect the camera to the power adapter. Plug the adapter into an outlet. Camera must be plugged in at all times.
2. Push the power button for about 2-3 seconds to turn on the monitor.
3. Turn the power switch to "On" to turn on the camera. A red LED indicator will illuminate if it is turned on.



- You can use the monitor while it is charging.
- Full Charging Time for Monitor: 5 - 6 hours.

Pairing Camera and Monitor



The units already come paired for your convenience.

The pair button is used to pair additional cameras. Users can assign numbers to the cameras. Up to 4 cameras may be paired.





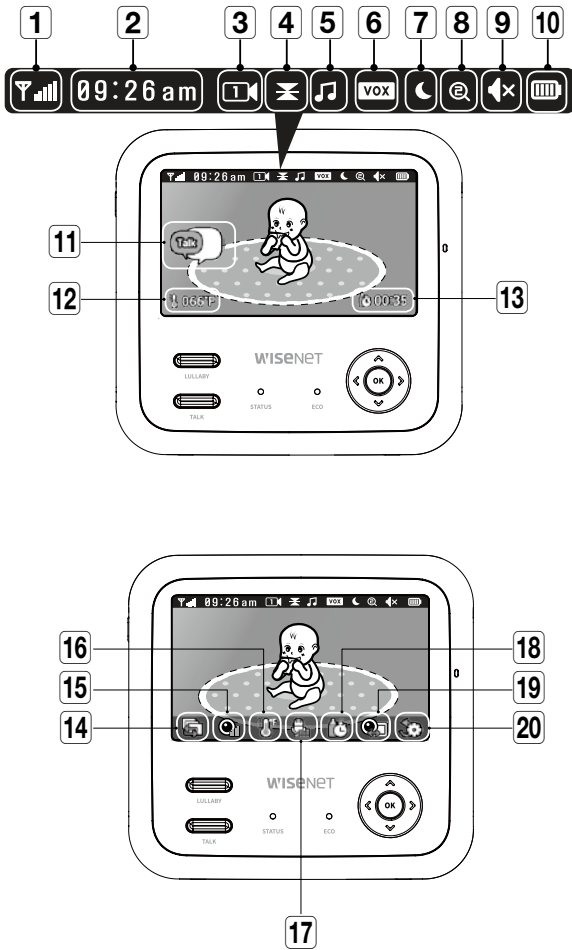

If you have an additional camera, pair your camera as follow:

1. Turn on the wireless monitor and new camera.
2. Press the "OK" button to make the settings icon appear on the screen.
3. Select the [] icon.
4. Select the camera number in the pair/unpair channel list.
The monitor will search for the new camera when set to pairing mode. A 30-second countdown will appear and start on the middle of the screen.
5. Press the [PAIR] button located on the rear of the camera.
6. If the monitor successfully pairs with the camera within the 30 second countdown period, the monitor will automatically switch to display the view of the newly paired camera.

User Interface Description



| No. | Icon | Name | Description |
|-----|------|---------------------|--|
| 1 | | Signal Indicator | Shows the signal strength between the camera and monitor. No bars indicate that the system is "Out of Range". |
| 2 | | Digital Clock | Displays the time that is set on the monitor. Time is displayed in 12-hr, AM/PM format only. There is no 24-hr format option. |
| 3 | | Camera Number | Indicates the camera currently being displayed on the monitor screen. |
| 4 | | Flipped image | Indicates when the image is flipped vertically. |
| 5 | | Lullaby | Indicates when a lullaby is playing. |
| 6 | | Vox Mode | Indicates when the camera is in VOX Mode. |
| | | Eco Mode | Indicates when the camera is in Eco Mode. |
| | | Video Mode | Indicates when Video Mode is On. |
| | | Audio Mode | Indicates when Audio Mode is On. |
| 7 | | Night Vision | Indicates when Night Vision is On. |
| 8 | | Zoom Mode | Indicates Zoom Mode is on. Zoom Level: x1/ x2 The camera(s) will zoom in and out sequentially when you press and hold the "OK" button. |
| 9 | | Audio Muted | Indicates the monitor's speaker is muted. |
| 10 | | Battery Power Level | Fully Charged Charging (When the battery is charging, the 2 icons above will show alternately.) Low Battery |
| 11 | | Two-Way Talk | Press and hold the talk button while talking. Two-Way Talk icon will appear on the screen when the button is pressed down. |
| 12 | | Temperature Display | Temperature Units: Fahrenheit/Celsius. |
| 13 | | Feed Timer Display | Displays reminders for baby's feeding time. |

| No. | Icon | Name | Description |
|-----|---|--------------------------------|--|
| 14 |  | View Mode | Select camera(s) to view and the viewing mode. |
| 15 |  | Brightness / Volume Adjustment | Adjust monitor brightness level: 1~5. Adjust monitor volume level: mute, 1~7. Adjust camera volume level: 1~5. |
| 16 |  | Temperature | Temperature display On/OFF, and set temperature. |
| 17 |  | VOX/ECO Sensitivity | Adjust VOX/ECO Sensitivity Level: Low or high sensitivity. |
| 18 |  | Feed Timer | Turn ON/OFF to display the baby feed timer. Set baby's feeding schedule. |
| 19 |  | Pairing | Pair/Unpair 1-4 Cameras. |
| 20 |  | System Menu | Set time and flip mode, or reset the monitor to factory settings. |

Button Description

Monitor

- Mode button: Press to change between modes (VOX - ECO - VIDEO - AUDIO). Mode Selection: select the desired mode, then the monitor will switch to the chosen mode.
- Power button: 1) Press and hold down for 2-3 seconds to turn ON/OFF the monitor. 2) When in On-Screen Display (OSD) mode, press the power button briefly to return to the previous interface.
- Lullaby button: Shows a list of Lullabies (#1-4: Lullabies, #5-7 White Noise, ALL: all Lullabies from #1-4).
1) Select a lullaby from the list to play and press "OK". 2) Press "OK" again to stop playing the lullaby, and press the "Lullaby" button to exit out of the lullaby list.
- Talk button: Press and hold button to speak.
- OK button: 1) Press to display menu or confirm selection. 2) When in View Mode, the camera will zoom in and out sequentially each time you press and hold the "OK" button.
- Direction button: The multi-directional keypad serves two purposes. 1) Menu Selection: Press the OK button to access the menu then use the multi-directional keypad to select an option. Press the OK button again once you have made a selection. 2) Camera Control: When in viewing mode, press the left or right arrow on the keypad to pan around the room or up or down to tilt and adjust the camera angle (mode: SEP-102CRW).

Camera

- Reset button: Press the reset button for at least 3 seconds to reset the camera.
- Power switch: Turn ON/OFF the camera.
- Pair button: Pair camera(s) to monitor.

Function Description

VOX (Voice activated)

Select to monitor and listen for significant sound levels with reduced ambient noise.

The monitor screen goes off in "VOX" mode after 30 seconds if there is no detection of significant sounds louder than the minimum noise level, but turns back on as soon as it detects sound that exceeds the minimum noise level.

You can set the sensitivity level in "VOX" mode.

- 'Low' Sound Level Detection : Sets to higher sensitivity.
- 'High' Sound Level Detection : Sets to lower sensitivity.

ECO Mode

In the energy-saving ECO mode, the screen goes off after 30 seconds if there is no detection of significant sounds louder than the minimum noise level. The monitor will not deliver any detected background sounds once the camera goes into this power saving mode, which helps decrease the RF radiation levels in the baby's environment. The monitor screen turns back on as soon as the camera detects sound exceeding the minimum noise level.

Video Mode

The screen is always in "Video" mode for continuous video and audio monitoring.

Audio Mode

The screen will turn off in "Audio" mode to only capture sounds around the camera(s) surrounding. The screen will turn back on by pressing any button on the monitor.

No Signal Warnings

An "Out of Range" message will appear when the baby monitor is out of the camera's range.

To improve the wireless signal strength, reposition the camera and/or the monitor closer to each other, or check the camera's power connection.

Sequence View

Select View Menu to enter into Sequence View. The sequence will start at Cam 1, then automatically switch to the next camera, Cam 2, after 10-seconds. When enabled, "Sequence View" will continue to change between cameras. To see details from a particular camera's view, just press the "OK" button to display the camera's view in full screen.



How to install

CAUTION: If you are using this system to watch a young child, please do not place the camera within the child's reach.

Wireless Monitor

1. Place the monitor in an area that provides clear reception to your camera(s).
2. Pull out the stand.



- Do not pull out the monitor stand with excessive force.



Wireless Camera

Before you install the camera, carefully plan where and how it will be positioned, and where you will route the cable that connects the camera to the power adapter.

Before permanently installing the camera, verify the camera's performance. Check the monitor's image quality when positioning the camera in the same location/position of where it will be installed, and where the monitor will be placed when being used.

Installation Warnings

Aim the camera(s) for optimal viewing: Select a camera location that provides a clear view of the area you want to monitor, which is free from dust and is not in direct line-of-sight to a strong light source or direct sunlight.

Avoid installing the camera where there are thick walls or obstructions between the camera and the monitor.

STRANGULATION HAZARD - Keep cord out of child's reach. NEVER place camera or cords within 3 feet of crib or playpen. Never use extension cords with AC Adapters. Only use the AC Adapters provided.

1. Carefully unpack the camera.

If you are installing cameras that did not come with the system, please see the camera pairing section in this manual for details on installation.

2. Mount the camera to the wall.

Mark the position of the screw hole on the wall, then drill a hole and insert a screw. Then firmly attach the camera to the wall by placing the stand over the installed screw and pushing the base downwards.

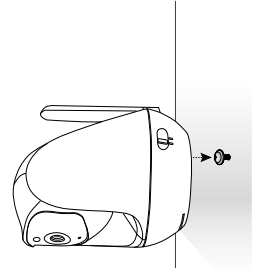

- To install on a concrete wall, drill a hole and use the plastic anchor so the camera is in a fixed position.
- The camera can also be placed on a flat surface, such as a table or shelf. Mounting hardware is not required.

3. Adjust the viewing angle of the camera.

Pan/tilt using the keypad on the monitor to adjust the viewing angle of the camera.

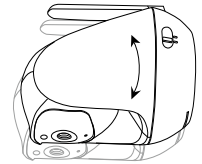

- Adjusting the camera with excessive force may damage the unit.



Trouble Shooting

| Problem | Solution |
|---|--|
| No picture from a camera | <ol style="list-style-type: none"> 1. Check all connections to the camera. Make sure the adapter is plugged in. 2. Make sure that the cameras and monitor are both ON. 3. Make sure that the camera is in range of the monitor. 4. Make sure the camera and monitor are paired. 5. Adjust the monitor antenna to a vertical position. |
| The picture is or has become choppy | <p>The picture may become choppy when experiencing a lower frame rate (i.e. 10 frames per second vs. a higher 20 frames per second).</p> <ol style="list-style-type: none"> 1. Try moving the camera closer to the monitor. 2. Remove obstructions between the monitor and camera. 3. Adjust the monitor antenna to a vertical position. |
| No sounds (even with both units turned on) | <ol style="list-style-type: none"> 1. Make sure that the power adapter is connected to the camera. 2. The battery on the monitor may be dead, be sure to charge it using the adapter included. 3. The monitor may be out of range from the camera. |
| Your BabyView Eco PT is emitting an high pitched noise/ feedback. | <p>This sound signifies normal feedback which occurs if the monitor and camera are too close together.</p> <p>Move the units apart, and the monitor will not emit high pitched noise/feedback.</p> |
| Monitor screen is frozen. | Restart your monitor and check the connection to the camera. If the baby monitor displays the "Out of Range" message, move the monitor closer to the camera. |



- Low battery will cause the supply current to become unstable and will affect the quality of the video/audio. Please charge the battery fully for superior video.



Product Specifications

| Item | Details |
|-----------------------------|--|
| System General | |
| Operating Frequency Range | 2400 MHz~2483.5 MHz |
| Type of Spread Spectrum TX | FHSS |
| Type of Modulation | GFSK |
| Number of Cameras Supported | Up to 4 cameras |
| Data Rate | 4Mbps |
| Transmission range | Up to 900ft (line of sight, no obstruction) |
| Regulation Compliance | FCC/CE(RoHS) |
| Operating Environment | 32°F~+104°F / 85% RH / Indoor use only |
| Wireless Camera | |
| Image Sensor Type | 1/4" Color CMOS Image Sensor |
| Effective Pixel | 640x480 (VGA) |
| Image Compression | MJPEG |
| Lens | EFL=3.95mm, F=2.2 (Viewing Angle (D): 55-degrees) |
| Night Vision | 16 ft. (5m) in the dark with 8 non-visible IR LEDs |
| White Balance | Auto |
| Lullabies | 4 songs + 3 white noises (Remote On / Off) |
| Pan Angle | 295° |
| Tilt Angle | 110° (+80° / -30°) |
| Temperature sensor | Yes (+/-2 degree) |
| Power Requirement | DC 5V ±10% |
| Power Consumption | 4.3Watt (max) |
| VOX level detection | Low: 50dBA / High: 65dBA |
| Audio | Built in Microphone/ Speaker |
| Wireless Monitor | |
| Display Information | 4.3" 480x272 Color TFT |
| Digital Zoom | X1 , X2 |
| Real Time Clock (RTC) | +/- 5sec / day |
| Power Requirement | Adapter : DC 5V ± 10%, Battery : 3.85V |
| Power Consumption | 4.0Watt (max) |
| Audio | Built in Microphone/ Speaker |
| Rechargeable Battery | 2100mAh Li-ion Polymer |
| Battery time duration | Monitor On: max. 5.5 hours / Audio Only: max. 10 hours |



Hanwha Techwin cares for the environment at all product manufacturing stages, and is taking measures to provide customers with more environmentally friendly products. The Eco mark represents Hanwha Techwin's devotion to creating environmentally friendly products, and indicates that the product satisfies the EU RoHS Directive.



Correct disposal of batteries in this product

(Applicable in the European Union and other European countries with separate battery return systems.)

This marking on the battery, manual or packaging indicates that the batteries in this product should not be disposed of with other household waste at the end of their working life. Where marked, the chemical symbols Hg, Cd or Pb indicate that the battery contains mercury, cadmium or lead above the reference levels in EC Directive 2006/66. If batteries are not properly disposed of, these substances can cause harm to human health or the environment.

To protect natural resources and to promote material reuse, please separate batteries from other types of waste and recycle them through your local, free battery return system.



Correct Disposal of This Product

(Waste Electrical & Electronic Equipment)

(Applicable in the European Union and other European countries with separate collection systems)

This marking on the product, accessories or literature indicates that the product and its electronic accessories (e.g. charger, headset, USB cable) should not be disposed of with other household waste at the end of their working life. To prevent possible harm to the environment or human health from uncontrolled waste disposal, please separate these items from other types of waste and recycle them responsibly to promote the sustainable reuse of material resources.

Household users should contact either the retailer where they purchased this product, or their local government office, for details of where and how they can take these items for environmentally safe recycling.

Business users should contact their supplier and check the terms and conditions of the purchase contract. This product and its electronic accessories should not be mixed with other commercial wastes for disposal.

MEMO

A series of horizontal dotted lines for writing.

Head Office

6, Pangyo-ro 319 beon-gil, Bundang-gu, Seongnam-si,
Gyeonggi-do, 463-400 Rep. of KOREA
Tel: +82.70.7147.8753, Fax: +82.31.8018.3740
www.wisenetlife.com

Hanwha Techwin America

500 Frank W. Burr Blvd. Suite 43, Teaneck, NJ 07666
Toll Free: +1.844.WISENET (947.3638)
Office: +1.201.325.6920, Fax +1.201.373.0124
www.wisenetlife.com

Hanwha Techwin Europe

Heriot House, Heriot Road, Chertsey, Surrey, KT16 9DT, United Kingdom
Tel: +44.1932.57.8100, Fax: +44.1932.57.810
www.wisenetlife.eu
