

SAMSUNG
WISENET

4M AHD Analog Bullet Camera

User Manual

SDC-89440BF

CE

4M AHD Analog Bullet Camera

User Manual

Copyright

©2016 Hanwha Techwin Co., Ltd. All rights reserved.

Trademark

Each of trademarks herein is registered. The name of this product and other trademarks mentioned in this manual are the registered trademark of their respective company.

Restriction

Copyright of this document is reserved. Under no circumstances, this document shall be reproduced, distributed or changed, partially or wholly, without formal authorization.

Disclaimer

Hanwha Techwin makes the best to verify the integrity and correctness of the contents in this document, but no formal guarantee shall be provided. Use of this document and the subsequent results shall be entirely on the user's own responsibility. Hanwha Techwin reserves the right to change the contents of this document without prior notice.

❖ Design and specifications are subject to change without prior notice.

IMPORTANT SAFETY INSTRUCTIONS

1. Read these instructions.
2. Keep these instructions.
3. Heed all warnings.
4. Follow all instructions.
5. Do not use this apparatus near water.
6. Clean the contaminated area on the product surface with a soft, dry cloth or a damp cloth. (Do not use a detergent or cosmetic products that contain alcohol, solvents or surfactants or oil constituents as they may deform or cause damage to the product.)
7. Do not block any ventilation openings, Install in accordance with the manufacturer's instructions.
8. Do not install near any heat sources such as radiators, heat registers, stoves, or other apparatus (including amplifiers) that produce heat.
9. Do not defeat the safety purpose of the polarized or grounding-type plug. A polarized plug has two blades with one wider than the other. A grounding type plug has two blades and a third grounding prong. The wide blade or the third prong are provided for your safety. If the provided plug does not fit into your outlet, consult an electrician for replacement of the obsolete outlet.
10. Protect the power cord from being walked on or pinched particularly at plugs, convenience receptacles, and the point where they exit from the apparatus.
11. Only use attachments/ accessories specified by the manufacturer.
12. Use only with the cart, stand, tripod, bracket, or table specified by the manufacturer, or sold with the apparatus. When a cart is used, use caution when moving the cart/ apparatus combination to avoid injury from tip-over.
13. Unplug this apparatus during lighting storms or when unused for long periods of time.
14. Refer all servicing to qualified service personnel. Servicing is required when the apparatus has been damaged in any way, such as power-supply cord or plug is damaged, liquid has been spilled or objects have fallen into the apparatus, the apparatus has been exposed to rain or moisture, does not operate normally, or has been dropped.



overview

SAFETY PRECAUTIONS



CAUTION

RISK OF ELECTRIC SHOCK.
DO NOT OPEN



CAUTION : TO REDUCE THE RISK OF ELECTRIC SHOCK, DO NOT REMOVE COVER (OR BACK) NO USER SERVICEABLE PARTS INSIDE. REFER SERVICING TO QUALIFIED SERVICE PERSONNEL.



This symbol indicates that dangerous voltage consisting a risk of electric shock is present within this unit.



This exclamation point symbol is intended to alert the user to the presence of important operating and maintenance (servicing) instructions in the literature accompanying the appliance.

WARNING

- To reduce the risk of fire or electric shock, do not expose this appliance to rain or moisture.
- To prevent injury, this apparatus must be securely attached to the floor/wall in accordance with the installation instructions.

WARNING

1. Be sure to use only the standard adapter that is specified in the specification sheet. Using any other adapter could cause fire, electrical shock, or damage to the product.
2. Incorrectly connecting the power supply or replacing battery may cause explosion, fire, electric shock, or damage to the product.
3. Do not connect multiple cameras to a single adapter. Exceeding the capacity may cause abnormal heat generation or fire.
4. Securely plug the power cord into the power receptacle. Insecure connection may cause fire.
5. When installing the camera, fasten it securely and firmly. The fall of camera may cause personal injury.
6. Do not place conductive objects (e.g. screwdrivers, coins, metal parts, etc.) or containers filled with water on top of the camera. Doing so may cause personal injury due to fire, electric shock, or falling objects.
7. Do not install the unit in humid, dusty, or sooty locations. Doing so may cause fire or electric shock.
8. If any unusual smells or smoke come from the unit, stop using the product. In such case, immediately disconnect the power source and contact the service center. Continued use in such a condition may cause fire or electric shock.
9. If this product fails to operate normally, contact the nearest service center. Never disassemble or modify this product in any way. (Hanwha Techwin is not liable for problems caused by unauthorized modifications or attempted repair.)
10. When cleaning, do not spray water directly onto parts of the product. Doing so may cause fire or electric shock.

CAUTION

1. Do not drop objects on the product or apply strong shock to it. Keep away from a location subject to excessive vibration or magnetic interference.
2. Do not install in a location subject to high temperature, low temperature, or high humidity. Doing so may cause fire or electric shock.
3. If you want to relocate the already installed product, be sure to turn off the power and then move or reinstall it.
4. Remove the power plug from the outlet when there is a lightning. Neglecting to do so may cause fire or damage to the product.
5. Keep out of direct sunlight and heat radiation sources. It may cause fire.
6. Install it in a place with good ventilation.
7. Avoid aiming the camera directly towards extremely bright objects such as sun, as this may damage the CMOS image sensor.
8. Apparatus shall not be exposed to dripping or splashing and no objects filled with liquids, such as vases, shall be placed on the apparatus.
9. The Mains plug is used as a disconnect device and shall stay readily operable at any time.
10. Do not expose the camera to radioactivity. Radioactivity exposure may damage the CMOS.



Apparatus shall not be exposed to dripping or splashing and no objects filled with liquids, such as vases, shall be placed on the apparatus

overview

CONTENTS

| | | |
|-----------------|----------|-------------------------------|
| OVERVIEW | 3 | Important Safety Instructions |
| | 4 | Safety Precautions |
| | 6 | Contents |
| | 7 | Product Features |
| | 8 | Part Names and Functions |

3

| | | |
|---------------------|-----------|--------------------------------|
| INSTALLATION | 9 | Precautions |
| | 9 | Installing the camera |
| | 10 | Protection of Cable from Water |
| | 10 | Connecting the DVR |

9

| | | |
|-----------------|-----------|-----------------------|
| APPENDIX | 11 | Product Specification |
| | 13 | Product Overview |
| | 14 | Troubleshooting |

11

PRODUCT FEATURES

- **High resolution**

Use the 4 mega-pixel CMOS, and provide high resolution equivalent to 1200TVL horizontal resolution.

- **High sensitivity**

The built-in high sensitive COLOR CMOS can produce a clear image. 0Lux (Auto IR LED On)

- **D-WDR (Digit Wide Dynamic Range)**

With the 4M-pixel CMOS sensor, this camera can provide a clear and quality image even under the circumstance of backlight, by way of and accurate exposure for the dark area and reducing exposure for the bright area: resulting in a clear, detailed and accurate image.

Package Contents

Check if the product package includes the following items.

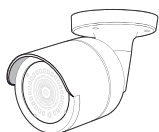

SDC-89440BF

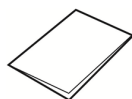

User Manual



Type L-Allen wrench



Screw



Anchor



60ft Camera Cable



- The appearance of the components may differ from the image shown.
- Depending on the model you purchased, there may be difference in the type and number of accessory.

overview

PART NAMES AND FUNCTIONS

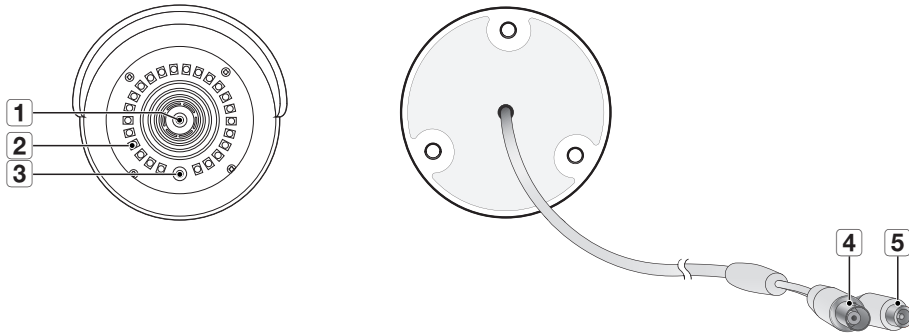

| Name | Description |
|------------------------------|--|
| 1 Lens | 3.6mm focal length enables you to monitor at a wider field of view |
| 2 IR LED | Infrared LED lights are controlled by the illumination sensor. |
| 3 Illumination Sensor | Detects incoming light to control the IR LED. |
| 4 BNC Cable | BNC terminal for video signal output. |
| 5 Power Cable | Use to power the camera. |

installation

PRECAUTIONS

Ensure you read out the following instructions before installing the camera:

- Select an area (ceiling or wall) that can withstand 5 times the camera weight
- Stuck-in or peeled-off cables can cause damage to the product or a fire.
- For safety purposes, keep anyone else away from the installation site.
And put aside personal belongings from the site, just in case.

INSTALLING THE CAMERA

The camera can be installed on the wall, ceiling, shelf or a desired position using the provided mounting bracket.

1. Choose an installation site that can sufficiently support the weight of the camera to be installed.
2. Adhere the installation template onto the ceiling and use it as installation locating tool. "Please refer to Page15 (Quick Guide)"

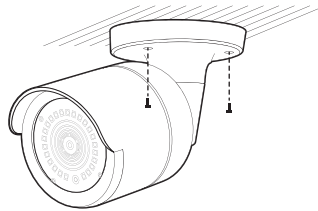
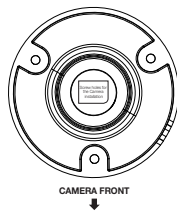

3. Attach the camera mount to the wall using the supplied screws.
4. Adjust the direction of the camera to the desired direction, and tighten the bracket.
5. Adjust camera angle as needed.

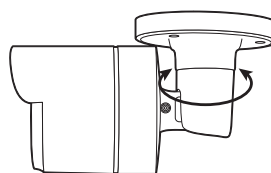
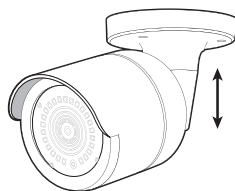

6. Connect the camera cable to the camera.
Take caution when installing the camera outdoors because the cable connectors may be wet with moisture or pile up with impurities.
Although the camera is IP66 rated, direct exposure to water or moisture may cause problem such as condensation.

installation

PROTECTION OF CABLE FROM WATER

If this product is mounted outdoor, water leakage may occur at gap between cables. As shown below, butyl rubber (available on the market) shall be used to protect from water.

1. Connect power supply and BNC power source.
2. Cover black sheath of the cable (Zone A), and ensure half of butyl rubber can cover the cable joint.



- Poor water protection at the cable sheath may cause water leakage. Make sure to wrap tightly.
- The water-proof butyl rubber is made of rubber that expands to twice the original length.
- If you do not use cable joint, it must be covered with water-proof tape.

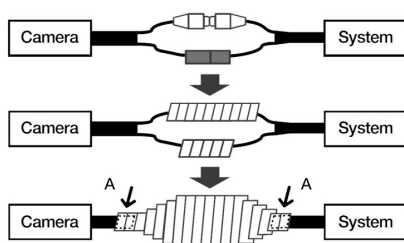

CONNECTING THE DVR

Connect the BNC connector of the camera to the enclosed 60ft camera cable, and then connect the BNC connector of the camera cable to the BNC Video Input port of the DVR.

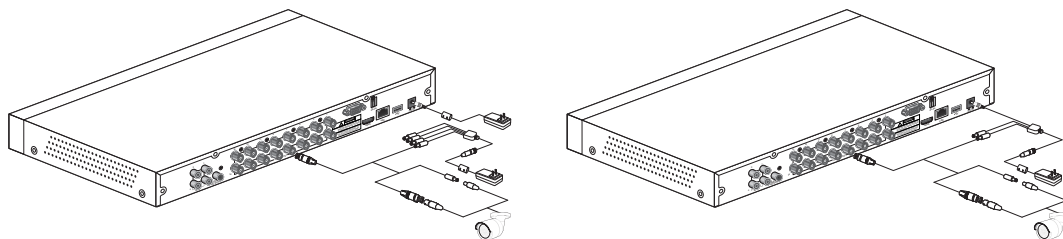

- The way to connect the power adaptor to the camera may vary depending on the DVR model. You may select one among the methods provided above as appropriate.

appendix

PRODUCT SPECIFICATION

| Item | Details |
|-------------------------|---|
| Video | |
| Imaging Device | 4M CMOS (1/3") |
| Effective Pixels | 2560(H) x 1440(V) |
| Scanning System | Progressive, 30fps(NTSC)/25fps(PAL) |
| Synchronization | Internal |
| Horizontal Resolution | 1440p |
| Min. Illumination | 0 Lux (IR LED ON) |
| Camera Output | Max. Transmission Length: 180ft (3EA attached 60ft camera cable combined) |
| Lens | |
| Focal Length | 3.6mm |
| Max. Aperture Ratio | F2.0±5% |
| Angular Field of View | 105° |
| Operational | |
| Shutter Mode | Auto(Rolling Shutter) |
| Gain Control | Auto |
| White Balance | Auto (1,800~10,500°K) |
| Wide Dynamic Range | D-WDR |
| Contrast Enhancement | N/A |
| Digital Noise Reduction | 2DNR |
| OSD | N/A |
| Flickerless | N/A |
| Day & Night | TRUE D/N, Auto |
| IR Distance | 25m/82ft (Total darkness) |

appendix

| Item | | Details |
|---|------------------|--|
| Environmental | | |
| Operating Temperature / Humidity | | -30°C ~ +50°C (-22°F ~ +122°F) / Less than 90% RH ※ Startup : -10°C ~ +50°C |
| Ingress Protection | | IP66 |
| Electrical | | |
| Input Voltage | | 12V |
| Power Consumption | | 5W |
| Mechanical | | |
| Color / Material | | White / Metal |
| Dimension (Ø x D) | | Ø68 x D149mm (2.68" x 5.87") |
| Weight | | 0.32kg |
| Accessory | Bracket | one body (assembled) |
| | Screw | 3 EA (per camera) |
| | Anchor | 3 EA (per camera) |
| | Hex key | 1 EA (per camera) |
| | Cable (60ft BNC) | 1 EA (per camera) |

PRODUCT OVERVIEW

unit : mm(inch)

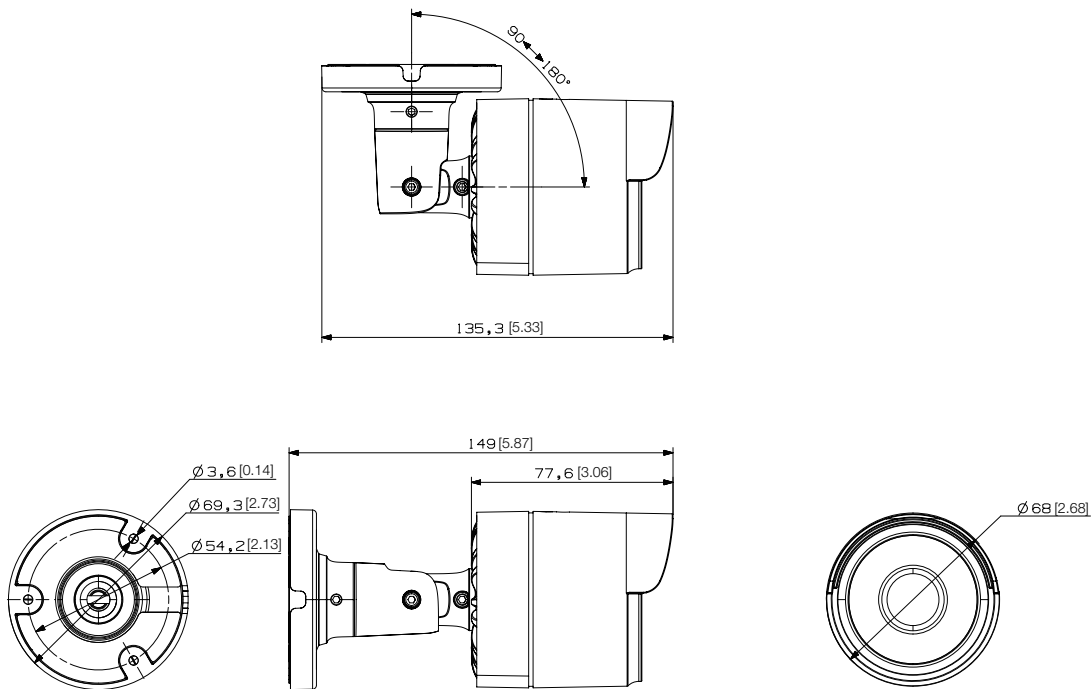

appendix

TROUBLESHOOTING

Please refer to the following table if you have problems during camera operation.

Please contact with the authorized technicians if your problem cannot be solved through the guidance.

| Problem | Troubleshooting |
|---|---|
| There is no content displayed on the screen. | <ul style="list-style-type: none">• Check whether the power cable and the cable between camera and monitor are connected correctly.• Check whether BNC cable is connected to the camera correctly.• Check if video system is the same as of DVR. |
| The image on the screen is dim. | <ul style="list-style-type: none">• Whether the lens is stained with dust. Clean the lens with soft and clean cloth.• Set suitable condition for the monitor or DVR.• If the camera is pointed to the strong light, please change the position of camera. |
| The image on the screen is dark. | <ul style="list-style-type: none">• Adjust the contrast ratio of monitor or DVR.• If there is intermediate equipment, please set 75Ω/Hi-z correctly. |
| The camera fails to work normally and the surface is hot. | <ul style="list-style-type: none">• Please check whether the camera is connected to suitable power supply correctly. |
| The color is incorrect. | <ul style="list-style-type: none">• Please check the setting of white balance setting menu. |
| The screen flickers constantly. | <ul style="list-style-type: none">• Please ensure that the camera is not pointed to the sun. |
| When the coaxial communication is not available | <ul style="list-style-type: none">• Please ensure that the camera and monitor are installed in the recommended distance.• If they exceed the recommended installation distance, please use coaxial and equivalent video amplifier. |



Any changes or modifications in construction of this device which are not expressly approved by the party responsible for compliance could void the user's authority to operate the equipment.

This device complies with part 15 of the FCC Rules. Operation is subject to the following two conditions: (1) This device may not cause harmful interference, and (2) this device must accept any interference received, including interference that may cause undesired operation.

This equipment has been tested and found to comply with the limits for a Class A digital device, pursuant to part 15 of the FCC Rules. These limits are designed to provide reasonable protection against harmful interference when the equipment is operated in a commercial environment. This equipment generates, uses, and can radiate radio frequency energy and, if not installed and used in accordance with the instruction manual, may cause harmful interference to radio communications. Operation of this equipment in a residential area is likely to cause harmful interference in which case the user will be required to correct the interference at his own expense.



Hanwha Techwin cares for the environment at all product manufacturing stages, and is taking measures to provide customers with more environmentally friendly products.

The Eco mark represents Hanwha Techwin's devotion to creating environmentally friendly products, and indicates that the product satisfies the EU RoHS Directive.



Correct Disposal of This Product (Waste Electrical & Electronic Equipment)

(Applicable in the European Union and other European countries with separate collection systems)

This marking on the product, accessories or literature indicates that the product and its electronic accessories (e.g. charger, headset, USB cable) should not be disposed of with other household waste at the end of their working life. To prevent possible harm to the environment or human health from uncontrolled waste disposal, please separate these items from other types of waste and recycle them responsibly to promote the sustainable reuse of material resources.

Household users should contact either the retailer where they purchased this product, or their local government office, for details of where and how they can take these items for environmentally safe recycling.

Business users should contact their supplier and check the terms and conditions of the purchase contract. This product and its electronic accessories should not be mixed with other commercial wastes for disposal.



Correct disposal of batteries in this product

(Applicable in the European Union and other European countries with separate battery return systems.)

This marking on the battery, manual or packaging indicates that the batteries in this product should not be disposed of with other household waste at the end of their working life. Where marked, the chemical symbols Hg, Cd or Pb indicate that the battery contains mercury, cadmium or lead above the reference levels in EC Directive 2006/66. If batteries are not properly disposed of, these substances can cause harm to human health or the environment.

To protect natural resources and to promote material reuse, please separate batteries from other types of waste and recycle them through your local, free battery return system.

Head Office

86 Cheonggyecheon-ro Jung-gu Seoul 04541 Korea
Tel +82.2.729.5277, 5254 Fax +82.2.729.5489
www.hanwha-security.com

Hanwha Techwin America

500 Frank W. Burr Blvd. Suite 43 Teaneck, NJ 07666
Toll Free +1.877.213.1222 Direct +1.201.325.6920
Fax +1.201.373.0124

Hanwha Techwin Europe

Heriot House, Heriot Road, Chertsey, Surrey, KT16 9DT, United Kingdom
Tel +44.1932.57.8100 Fax +44.1932.57.8101
